

USED CONTAINER AS A TEMPORARY 'PUBLIC TOILET'

**I Putu Widjaja Thomas Brunner, R. Roni Gursala,
Roy Marko Tinamnunan, David Hayatullah**
Department of Architecture-Institut Teknologi Basional
PKH Mustafa 23 Bandung 40124
brunner@itenas.ac.id
ph 022-7272215, fax 022-7202892

ABSTRACT

A disaster is a misfortune that is always detrimental to the human race and can be caused by nature (natural disaster) and human-made (man-made disaster). Disasters caused by nature are the most cause to greatest loss over time. Impact and losses are so fatal to humans and the environment, both directly and indirectly. Direct losses may be death, injury, disability and property while the indirect losses impact on post-disaster such as mental and physical health disorders. Losses in terms of environment resulting in damage of physical order like infrastructure such as public infrastructure, and non-physical structure like the disruption of the stability of the social, cultural, health and the economy in the affected areas both macro and micro effects.

Problems generally arise when the post-disaster evacuation, provision of accommodation, and the most important part is the provision of water and sanitation facilities to support activities such as the provision of disaster victim's toilets, kitchen and medical facilities. The handling of the issue of the problem requires the participation of all society layers and humanitarian organizations in the affected areas as well as the involvement of professional architects to help realize the needs of the emergency.

In case of disaster, so far architectural disciplines contribute in helping the government aimed at the realization of design concepts for easy procurement of the primary means of victim evacuation after natural disasters. These reasons encourage the desire to do a concept design study of shelter for post-disaster used containers specifically for emergency sanitation facilities.

KEY WORDS: disaster, sanitation facilities, emergency needs, a former container

PROBLEM IDENTIFICATION

How to produce an effective design concept of post-disaster shelter sanitation in post-disaster first treat by looking at the following issues:

1. Social problems affected areas. Generally the social aspect in Indonesia is still upholding sense of community (mutual help) when a disaster happen, especially in remote, rural, suburban. Meanwhile, Indonesia's multicultural society creates a different response in each region. Both daily behavior, social activities, and goals are different.
2. Problems and Indonesia topography influence the design concept of post-disaster shelter. From the aspect of topography, Indonesia is a maritime country with gentle contours (coastal areas) and extreme contours (mountainous regions).
3. Sanitation needs problems in the camps. Sanitation needs of each person is different depending on the type of need. The larger the population of a region, the greater the demand. Sometimes can be happen the change of unexpected population like displacement case that requires special attention in determining the amount of the facility.
4. Former container utilization for the provision of sanitation functions so temporary and moveable.

Aims and Objectives

By looking at the problem from the problem identification, the intent and purpose of this discussion paper is:

1. Generate concept design of temporary post disaster shelter that adaptable, fast, and easy, with a focus on sanitation functions to improve environmental health of disaster evacuation.
2. Being proposed as reference concept in the provision of sanitation facilities at natural disasters refugee, especially in Indonesia.
3. Assist in improving quality of first aid care to victims of natural disasters.

Concept of Disaster Handling

A disaster is an event or sequence of events that led to serious disruption to the community, causing death and widespread damage to human life both in terms of material, economically and environmentally, and beyond the ability of society to cope using their own resources.

In short when the threat of adverse human and environmental impact, and the absence of the ability of people to cope is called disaster. The relationship between threats, vulnerabilities and capabilities can be described as follows:

$$\frac{\text{Threats} \times \text{Vulnerabilities}}{\text{Capabilities}} = \text{Disaster Risk}$$

Disaster Management is a sequence of events both before, during and after a disaster to prevent, reduce, avoid, and recover from the impact of disasters (Fig.1). In general, the activities carried out in disaster handling are as follows: prevention, hazard mitigation, preparedness, response, recovery (rehabilitation and reconstruction), and sustainable development that reduce disaster risk. Here is a picture of the cycle of disaster management generally:



Fig.1 (Disaster Management Cycle)

Emergency response aims to save people who are still alive, able to survive and immediate basic needs of the most minimal deployment efforts that focus on all the potential natural disaster in order to find, rescue and rescue of victims of natural disasters and provide emergency services in a timely, appropriate and coordinated.

Emergency response activities focused on the following:

1. Emergency relief
2. Handling of refugees
3. Health care, sanitation and clean water
4. Cleaning the city
5. Preparation of temporary shelters
6. Evacuation and burial of victims

Emergency efforts that include:

1. Immediately help survivors
2. Immediately improve basic facilities and infrastructure to be able to
3. Providing adequate services to victims
4. Immediately bury the bodies of victims

Post-Disaster Social Issues

Availability of drinking water and sanitation and hygiene is very important to maintain in order to survive at all stages of an emergency. In many emergency situations, people susceptible to disease and die from diseases transmitted through water. Women and children are particularly at risk because they are usually the largest percentage of the poor and the majority of refugees, in many traditions of men priority in the distribution of food and drinking water are limited.

When using public water facilities and sanitary latrines in particular activities, women and girls vulnerable to sexual violence. To minimize this risk, it is important to involve the participation of women in water supply and sanitation programs creation, especially for site selection, build and maintain the facilities. Preparation of water supply and sanitation systems in the form of toilets, including the dissemination of information, should be done after having an understanding of the community, including data on the number of people based on gender, gender analysis, and security considerations.

From the map below (Fig. 2) shows that in the west coast of Sumatra, the south coast of Java

and NTT kep an earthquake-prone areas that have an earthquake dots in the sea where the area is also a tsunami-prone areas, as earthquake that occurred in the ocean can cause faults in the ocean floor causing a huge wave (Tsunami causes).

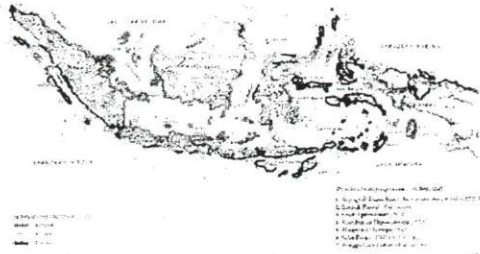
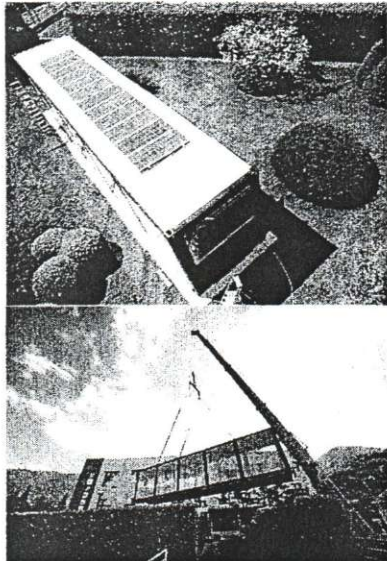

Fig.2 (Map Level Tsunami Vulnerability in Indonesia)
(Source: Meteorological and Geophysical Agency of Indonesia)

Used Containers Architecture

Their low cost, easily transportable and modified, strength of the material that has been tested (ISO shipping container types), and inadequate treatment of the environment at the site that will be the location of a former container are the advantages sequence of usage of used container.

GREENTAINER



Greentainer Project is a project of making a container converted into a multipurpose space or can be used for various purposes.

PUSH BUTTON HOUSE

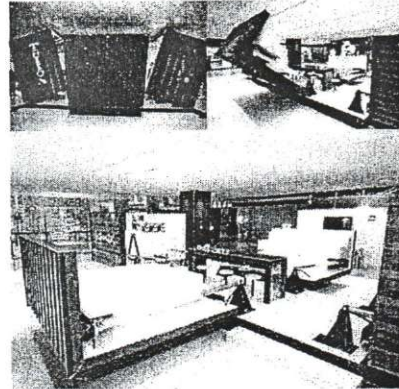

The house designed by Adam Kalkin is indeed deserves to be called "Push Button House" (Push Button House).

The Illy's Push Button House is a house that the original form of a container that we usually encounter in the harbor or the highway, but with a single press of the button the container will be turned into a complete home with 5 rooms, the bedrooms, kitchen, living room , library and ofcourse toilet.

Sanitation

Sanitation is intentional behavior in the cultivation of clean living human beings for the purpose of preventing direct contact with sewage and other hazardous waste materials in the hope business will maintain and enhance human health.

Waste material that can cause health problems consist of human or animal feces, leftover material of solid waste, domestic waste material water (washing, urine, waste material bathing or laundry), industrial waste materials and agricultural waste material. How to clean prevention can be done by using technical solutions (eg washing treatments and the remaining liquid waste), simple technologies (eg latrines, septic tanks), or the practice of personal hygiene (eg washing hands with soap).

sanitation is directly related to:

1. Health.
2. The use of water.
3. Fees and cost recovery.
4. Re-use of water.

Sewerage System

There are several kind of Sewage or feces treatment system. Some of the advantages and disadvantages of treatment systems include:

1. Septic tank
2. Constructed Wetland
3. Composting Toilet
4. Anaerobic Baflet Reactor (ABR)
5. Bio-Digester

Shelter

Shelter is one of the basic needs and protection of refugees. Shelter can be used as a shelter, medication, communications, public toilets, a source of electrical energy, the school, temporary dead body cooler , and so on. Providing shelter for refugees conducted in two stages approach. In the first stage of his top priorities is the provision of shelter for a short time, fundamental, and temporary. The second stage is the provision of shelter for the long-term, sustainable and permanent. There are several important considerations for the first phase of a reference by Emma Cubitt in his book 'Temporary Emergency Shelter' to design an emergency shelter that is:

1. Weight and size are directly related to the ease and cost of transport towards the tread.
2. Can be produced in large quantities within a certain time limit.
3. The cost of building shelter
4. Material procurement capabilities accordingly.
5. The use of local materials (disaster area) / use of waste materials.
6. Construction is easy to work with a local technician or refugees.
7. No need minimal work or development of the land for development.
8. Rapid development.
9. Flexibility usage and can be customized.
10. Livable and comfortable
11. Long endurance (depending on each individual's needs, but ideally for a period of 6 months before a permanent set)
12. The integrated structure and earthquake resistant
13. Resistance to wind and rain storms especially in regions prone to hurricanes
14. Issues and thermal insulation (for cold climates) and ventilation (for humid climates)
15. Easy to use dismantled and re-

16. The beauty and charm, privacy.

Containers as a Used Material

Containers are easy to find in Indonesia, particularly in the area of the port due to its function as a container or package to deliver the goods. Even today a lot of used containers that are not used anymore and abandoned just as industrial waste. With a strong and rigid material and durable, the container could potentially be developed into a temporary shelter functions.

Comparative Advantages and Weaknesses Shelter Containers

Variable Emma Cubitt "Tempora ry Emergency Shelter"	Shelter Tent	Shelter Dome	Rubbel-built	Shipping pallet	Shed Shelter	Container Shelter (Prefab buildings)
Weight & size	++ ++	++ ++	++	+++ +	++ +	+
Can be mass produced	++ ++	++ +	+	+++	++ ++	+++ +
Cost of build	++ +	++ +	++ ++	+++	++	+++ +
Material procureme nt capabilities	++ +	++ +	++ ++	+++	++	+++ +
Use of waste materials	++ +	++ +	++ +	+++ +	++	+++ +
Easy construct by local technicians	++	+	++ ++	+++	+	+++ +
Minimum of land works	++	++	++	++	++ ++	+++ +

Speed of development	++	+	+	+++ +	++	+++ +
Flexibility	++ +	++	+	+++ +	++ +	+++ +
Livable	+	++	++ +	-	++	+++ +
Durability	-	++	+	-	++	+++ +
Integrated structure (earthquake resistant)	-	-	-	-	+	+++ +
Resistance to wind and storm	-	+	-	-	++	+++ +
Insulation & ventilation	-	-	+	-	++	+++ +
Easy to dismantled and reused	++	+	-	+++ +	++ ++	+++ +
Aesthetics	+	++ +	++	-	+	+++ +
privacy	-	+	+	-	+	+++ +

Note :

”+” = supporting

”-” = not supporting

Mapping Issues and Use Containers

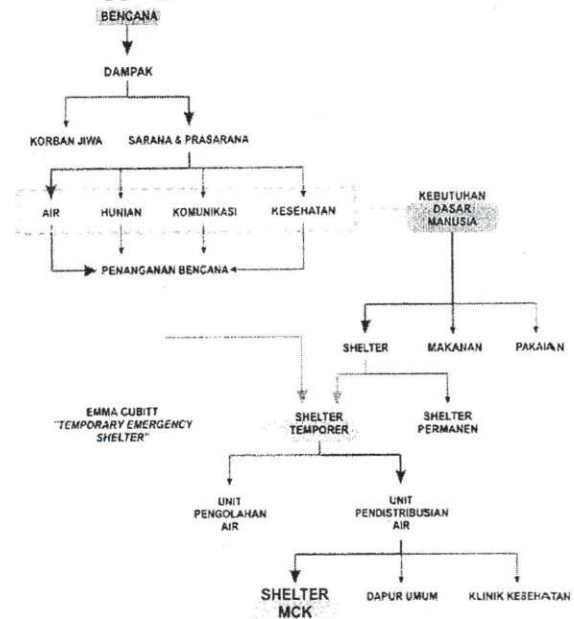

Characteristics Analysis of Post-Disaster Latrines

Availability of public toilets infrastructure needed to support basic needs of water to be conditioned to survive at disaster emergency. Infrastructure as part of a sanitary latrines need to consider the quality of health, especially in the refugee camps.



In addition to hygiene, comfort and safety public toilet also must be taken to avoid cases of rape and sexual abuse, especially at night in the refugee camps. In the area of displacement, women and children are particularly vulnerable to sexual abuse when using public water facilities and sanitation toilets in particular activities. Local social behavioral factors also need to be considered to avoid opposition to daily habits and actions that may damage the infrastructure. From the problems above, special handling is required for society in Indonesia in

the design of public toilets in order to prevent and reduce the risks such as:

1. Provision of public toilets which is separating activity zone men and women.
2. Location, design and feasibility public toilets design maximizes the safety and security of users especially women and children.
3. Facilitate control and not difficult for women to indulge in the toilet.
4. For bathing facilities must have a door with a lock on the inside.
5. Facilities must be open to the public, can be achieved and have adequate lighting for the safety of the user.
6. Consideration of the options and the local cultural customs in determining the type of latrines to be built.
7. Provide special sanitary bins and toilet tissue in women's toilet.
8. Ease of maintenance sanitary infrastructure with an appropriate design. avoid designs that facilitate the destruction and theft of the components of the infrastructure (related to people's behavior).
9. Public toilet activity area division between women and men with a ratio of 3 to 1 (according to the general guidelines).

Architectural analysis

Judging from the problems of the main needs of the refugees of natural disasters are like food and shelter that provides a sense of comfort. From the problems above, it can be determined the main functions in shelter facilities water supply is ready for use, ie; shower function, wc, and wash clothes. Below is the flow of public toilet activity of men and women:

1. Men → activity occurring; bathing, defecating, taking water
2. Women → activity occurring; bathing, defecating, fetching water, washing

Form and Circulation Analysis

Forms of shelter are required to attend a function in it. Which is expected to create an efficient space with good circulation. There are some basic forms of shelter that is used to this day in the form of circles, triangles, squares, rectangles, etc.. From the above geometric forms, the most efficient form with function as a shelter means that toilets are required to have a flexible circulation (simple) on the activities therein are basic rectangular geometry.

Structural Systems and Construction

Analysis

Emergency shelter does not need the soil cultivation work, rapid development and has a long durability depends on the conditions and refugee's needs (ideally for a period of 6 months before permanent residence is established).

Shelter structures used must be integrated and earthquake resistance. In addition to easily disassembled and reused. Therefore, the shelter should be designed in the form of a single unit module components. The modules can be manufactured in large quantities at a certain time limit (prefabricated) and produces a shelter units that already includes functions public toilet therein. So the fitting construction of the shelter unit is easily done by a local technician or by disaster refugee.

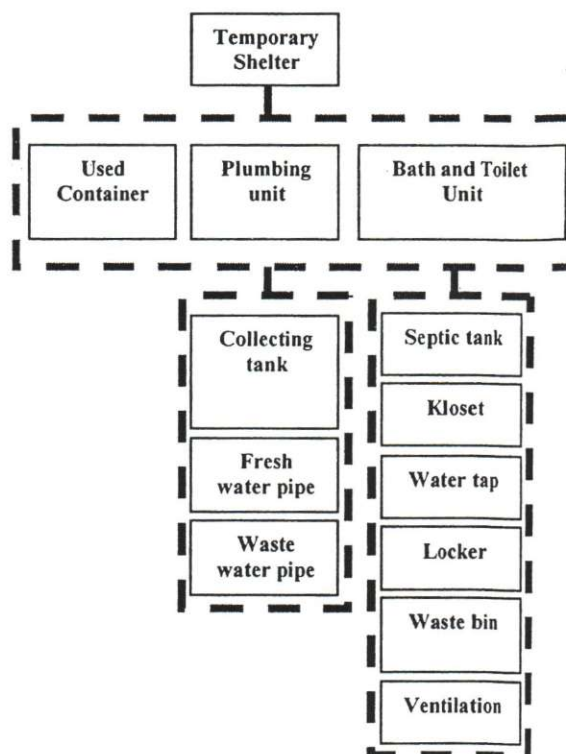

Utilities analysis

Air circulation of shelter using natural airing is in the form of ventilation aperture.

For the condition of the unavailability of energy sources such as electricity generators in the disaster area, shelter lighting at night can use artificial energy as solar energy.

By looking at the main function of shelter as latrines, water piping system utility is designed integrated with other components in one unit shelter with water separation system utilities and sewage. Water utility system consists of storage tanks and piping.

Wastewater utility system consists of a temporary septic tank and disposal of solid and liquid wastes.

Design concept

The basic concept of the design is to create an infrastructure of post-disaster public toilet shelter from used containers of functionally integrated supporting multiple sub-functions making it easy and practical to use to adequate the basic needs of the disaster victims, especially in Indonesia.

Shelter is designed with consideration to the social behavior of local communities that affected by the disaster and to provide comfort and safety for users especially vulnerable to sexual harassment of women. In addition, the effectiveness of the design in terms of production, transportation and supply at the site is emphasized in design shelter character.

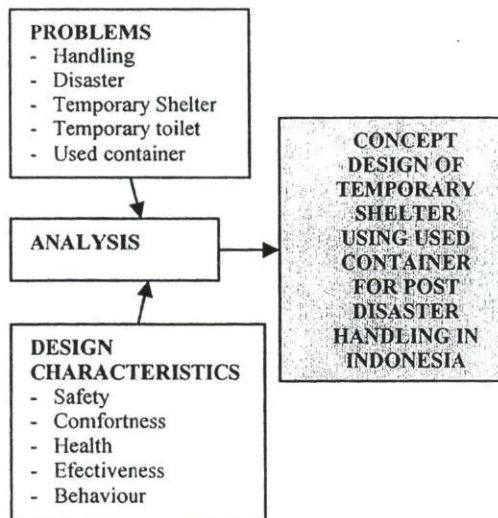

Container Design Concept

Typical forms of container and raw form of rectangular beams to basic form of shelter design that functions in it to adjust with the shape.

The basic form containers later developed into a more functional by specific modifications of the skin and the interior of the container in the form of typical units which allows adjustment of the container shape.

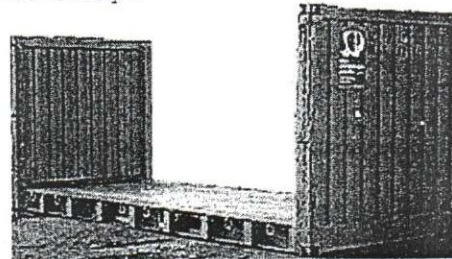
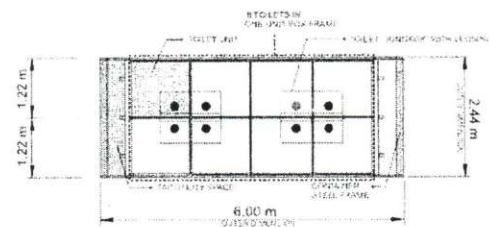
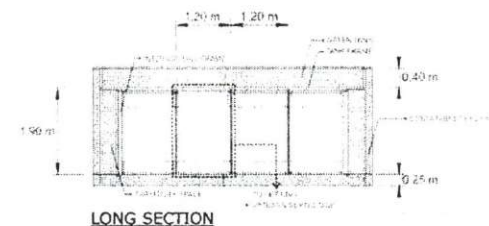

Fig.3 (Container structure)



FLOOR PLAN

Fig.4 (Shelter Plan)



LONG SECTION



LONG ELEVATION

Fig.5.(Shelter long section)

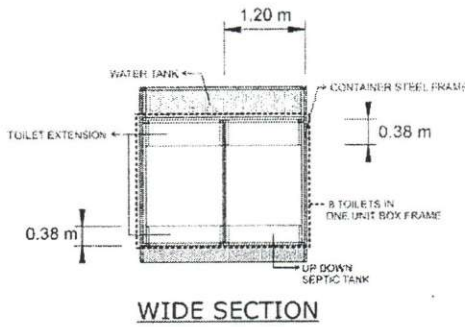

WIDE SECTION

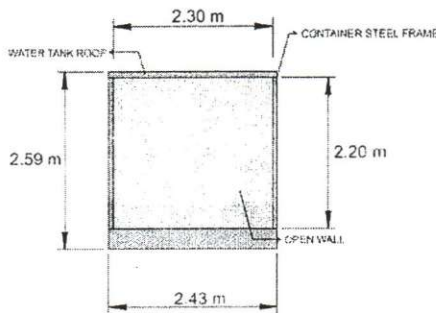

WIDE ELEVATION

Fig.6 (Shelter wide section)

Circulation and Space Grouping

Circulation in the shelter are separated by gender, women and men with special emphasis on safety by women activities isolation in toilets. Women Circulation into activity areas inside the shelter is designed in the opposite direction of men circulation. In the area of women's activities given the circulation of a large communal space which is private only for women washing activities.



Fig.7 (Activity zone for male and female)

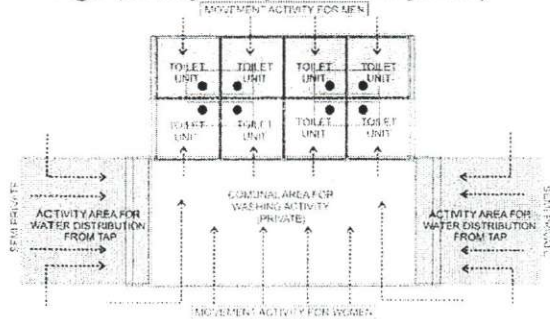

Fig.8 (activity model for male and female)

The room / area grouping in the shelter only divided into two main areas, namely women latrine activity area and men latrine activity area and each is private. As for the extraction of water from the faucet on the side of the shelter is semi-public.

Shelter Security Systems

Shelter security system is divided into two, namely:

1. Safety, security of the fire prevention precautions (use of fireproof material) for coating the shelter. Prevention of accidents for users with a safety dimensions of the room.
2. Security, its security precautions against adverse actions by humans. Such as security of the spaces that are private to those who are concerned. Furthermore, the placing activity zone especially women should ease the supervision.

Structures and Construction Concept

System structure of the shelter is divided into two, namely:

1. container Skin structure system, a modification of the basic structure of a container that was developed on each side of the wall to be opened into the roof or floor of the shelter. Modification does not throw the old container frame wall but only by cutting off according to the dimensions of the design and delivery of such systems hinge joint connection or iron holder

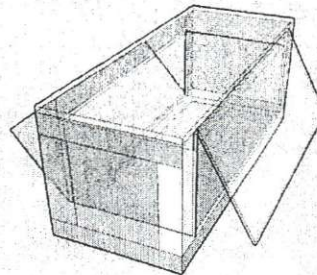
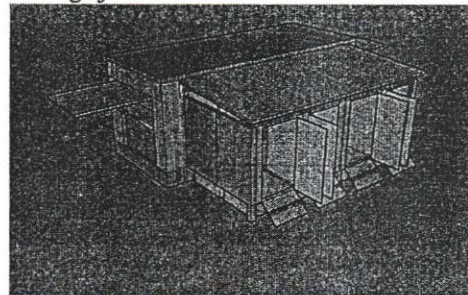

Fig.9 (container perimeter structure)

2. System structure of the toilet unit, in the form typical modules totaling 8 units in a shelters with prefabricated production system. Structures that built already integrated with components such as piping and ventilation. The structure of the unit consists of a steel frame and steel plate as a wall of toilet unit which are connected by welding and septic tanks are made of steel frame and aluminum.

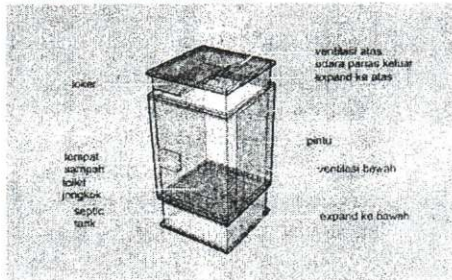

Fig.10 (toilet compartment unit)

The following stages of work providing latrine shelter:

1. The basic form is a package shelter in an enclosed container.

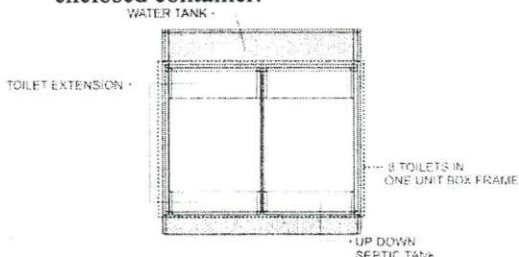

Fig.11 (Basic Design of Shelter)

2. Furthermore, the frontside wall of the container, rear and side are opened up and down.



Fig.12 (Opening stage of perimeter)

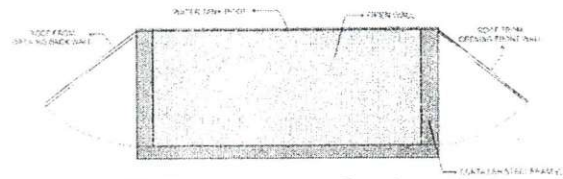

Fig.13 (Opening stage of perimeter)

3. The next stage is removing the toilet units box by pushing out from the side of the container that has been opened up. At this stage the logs used for anchoring while the box is removed.

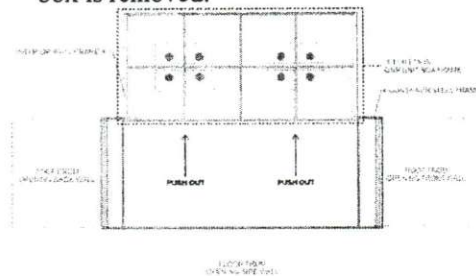

Fig.14 (Stage of extending toilet units)

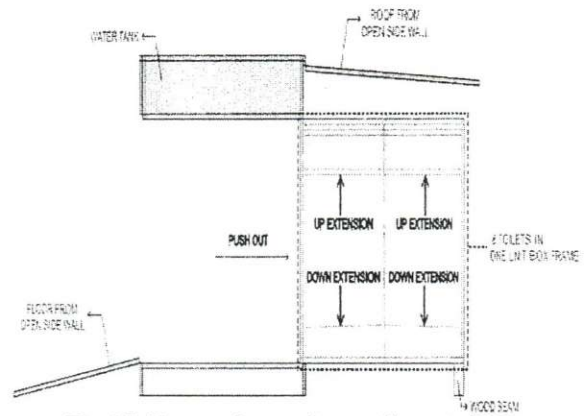

Fig.15 (Stage of extending toilet units)

4. The final stage work is pulling the extension toilet unit up and down.

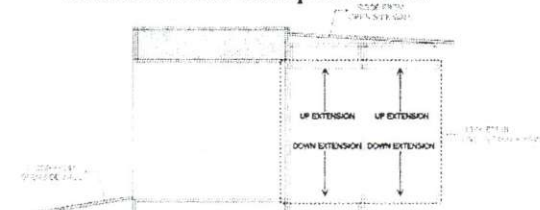

Fig.16 (Stage of extending toilet units)

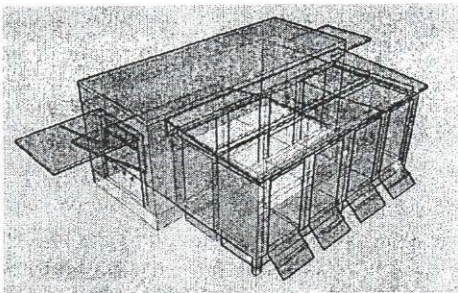

Fig.17 (Final stage after extending all unit)

The concept of utility

Water piping utility system is designed integrated with other components in a single unit container with a separate of clean water and sewage utility system. Network utility piping from water tank connected to the utility grid toilet unit piping and valves using additional pipe connections. Then clean water from the water management unit which are accommodated in temporary tank container can be channeled to toilet units and faucet through the available pipes.

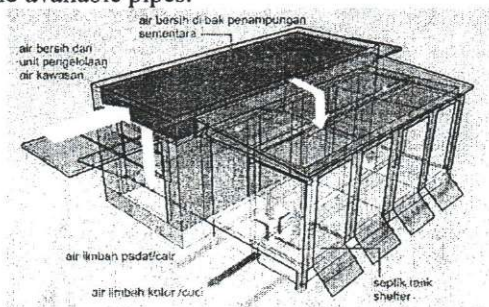

Fig.18 (Plumbing scheme for fresh water and waste water)

Bio Digester

In this processing unit, waste mixture is going to happen evenly and precipitation occurs. Sludge is also undergoing a process of biogas formation by bacteria and will also reduce the volume of sludge. Digester is made of plastered masonry until waterproof and airproof so that biogas can be captured and can be used as a substitute for petroleum energy sources.

1. Usage
Bio Digester just accept toilet waste/ feces only, not for water used (bathroom and laundry)
2. Maintenance
 - a. Do not dispose of hazardous chemicals into the Bio Digester, such as

insecticide, carbolic floor cleaners, bleach clothes.

- b. Sludge dewatering septic tank results are harmful to humans and the environment, necessitating further processing.
 - c. Cultivated in care to prevent leakage.
 - d. Keep the fire away of the gas drainage holes.
3. Benefit bio digester
 - a. Effective as initial treatment
 - b. Low Construction and maintenance costs
 - c. Needs a bit of land
 - d. Water processed odorless
 - e. Produce gas
 4. Disadvantages bio digester:
 - a. Still required further processing
 - b. Necessary expertise to design, supervise and construct

Air conditioning

Air circulation at the shelter is focused on the toilet unit using the natural airing in the form of ventilation aperture on the walls and roof of the unit. The cold air will come in from the bottom vents and hot air will come out of the vents above. Whereas for overall shelter airing is enough by taking advantage of aperture/opening on the side wall of the container.

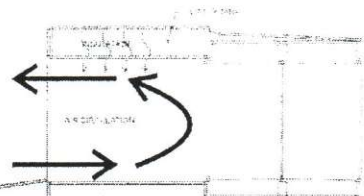

Fig.19 (Air circulation and heat insulation)



Fig.20 (Air circulation and ventilation at a toilet compartment unit)

CONCLUSION

It was concluded that the design characteristics specific to post-disaster latrine (public toilet) is different with general toilets. It needs consideration of emergency and local conduct that resulted an effective design and practical in the treatment (maintenance) of not forgetting the safety factor and comfort of users, especially women and children as a vulnerable group.

REFERENCES

Anisya Thomas, Fritz Institute. (2008). *Linking preparedness and performance: The tsunami experience*.

Badan Meteorologi dan Geofisika Indonesia

BAKORNAS, Penanggulangan Bencana dan Penanganan Pengungsi 2006-2009.

Emma Cubitt, *Temporary Emergency Shelter*.

Jim Kennedy, Joseph Ashmore, Elizabeth Babister and Dr Ilan Kelman. (2008), *Post-tsunami transitional settlement and shelter: Field experience from Aceh and Sri Lanka*. Available : 2008.

Microsoft Encarta Premium (2006).

Staf Pengajar Sosiokomunikasi.

2007. *Metode Penulisan Ipteks*. Bandung : Penerbit ITB.

<http://www.odi.org.uk>

Wikipedia Bahasa Indonesia

www.idepfoundation.org/PBBM